



PATTERN BOOK
VIQHA GLACIER CLASSIC

July 16 - Judge Carolyn Rice

July 17 - Judge Christi Brown

Glacier Classic - Duncan

Start Time 8am

July 16 - Judge Carolyn Rice

1. Yearling Stallions, Open
2. Two Year Old Stallions, Open
3. Three Year Old Stallions, Open
4. Aged Stallions, Open
5. Performance Stallions, Open
GRAND AND RESERVE

6. Amateur Stallions, Yearling
7. Amateur Stallions, 2 Year Olds
8. Amateur Stallions, 3 Year Olds
9. Amateur Stallions, Aged
10. Amateur Stallions, Performance
GRAND AND RESERVE

11. Yearling Geldings, Open
12. Two Year Old Geldings, Open
13. Three Year Old Geldings, Open
14. Aged Geldings, Open
15. Performance Geldings, Open
GRAND AND RESERVE

16. Amateur Geldings, Yearling
17. Amateur Geldings, 2 Year Olds
18. Amateur Geldings, 3 Year Olds
19. Amateur Geldings, Aged
20. Amateur Geldings, Performance
GRAND AND RESERVE

21. Youth Geldings, Yearling
22. Youth Geldings, 2 Year Olds
23. Youth Geldings, 3 Year Olds
24. Youth Geldings, Aged
25. Youth Geldings, Performance
GRAND AND RESERVE

26. Yearling Mares, Open
27. Two Year Old Mares, Open
28. Three Year Old Mares, Open
29. Aged Mares, Open
30. Performance Mares, Open
GRAND AND RESERVE

31. Amateur Mares, Yearling
32. Amateur Mares, 2 Year Olds
33. Amateur Mares, 3 Year Olds
34. Amateur Mares, Aged
35. Amateur Mares, Performance
GRAND AND RESERVE

July 17 - Judge Christi Brown

36. Youth Mares, Yearling
37. Youth Mares, 2 Year Olds
38. Youth Mares, 3 Year Olds
39. Youth Mares, Aged
40. Youth Mares, Performance
GRAND AND RESERVE

41. **Showmanship Stakes (Sunday Only)**
42. Showmanship L1 Youth
43. Showmanship Youth
44. Showmanship L1 Amateur
45. Showmanship Select Amateur
46. Showmanship Amateur

47. Lungeline Futurity (open Breed)

- Break - length to be announced*

48. **HUS All Ages / All Breed Stake (Sat only)***
49. **HUS Youth Stake / All Breed (Sat Only)***
50. Hunter Under Saddle L1 Open Horse
51. Hunter Under Saddle L1 Walk/Trot
52. Hunter Under Saddle Youth L1 Walk/Trot
53. Hunter Under Saddle L1 Youth
54. Hunter Under Saddle Youth
55. Hunter Under Saddle L1 Amateur.
56. Hunter Under Saddle Select Amateur
57. Hunter Under Saddle Amateur
58. Hunter Under Saddle All Ages Horse (AQHA)

59. Hunt Seat Equitation Amateur L1 Walk/Trot
60. Hunt Seat Equitation Youth L1 Walk/Trot
61. Hunt Seat Equitation L1 Youth
62. Hunt Seat Equitation Youth
63. Hunt Seat Equitation L1 Amateur.
64. Hunt Seat Equitation Select Amateur
65. Hunt Seat Equitation Amateur

Lunch Break to be announced!

Glacier Classic July 16 & 17

Start time 8:00am

66. Trail Open L1 Horse
67. Trail L1 Walk/Jog
68. Trail Youth L1 Walk/Jog
69. Trail L1 Youth
70. Trail Youth
71. Trail L1 Amateur
72. Trail Select Amateur
73. Trail Amateur
74. Trail All Ages (AQHA) Horse
75. Trail - Ranch AQHA Youth
76. Trail - Ranch AQHA Amateur

77. **W P Stakes All Ages/All Breeds (Sunday Only)**
78. **WP Youth Stakes/All Breeds (Sunday Only)**
79. Western Pleasure Open L1 Horse
80. Western Pleasure L1 Walk/Jog
81. Western Pleasure Youth L1 Walk/Jog
82. Western Pleasure L1 Youth
83. Western Pleasure Youth
84. Western Pleasure L1 Amateur
85. Western Pleasure Select Amateur
86. Western Pleasure Amateur
87. Western Pleasure Open All Ages (AQHA) Horse

88. Western Horsemanship Amateur L1 Walk/Jog
89. Western Horsemanship Youth L1 Walk/Jog
90. Western Horsemanship L1 Youth
91. Western Horsemanship Youth
92. Western Horsemanship L1 Amateur
93. Western Horsemanship Select Amateur
94. Western Horsemanship Amateur

95. Western Riding Youth
96. Western Riding Amateur
97. Western Riding All Ages

98. Ranch Horse Riding Stakes (Saturday)
99. Ranch Horse Riding Youth
100. Ranch Horse L1 Amateur
101. Ranch Horse Riding Select Amateur
102. Ranch Horse Riding Amateur
103. Ranch Horse Riding All Ages

104. Reining L1 Amateur
105. Reining Select Amateur
106. Reining Amateur
107. Reining All Ages

Glacier Classic July 16

Showmanship Youth, Amateur and Select (all ages)

Show Date: 07-16-2022

www.HorseShowPatterns.com

www.HorseShowPatterns.com

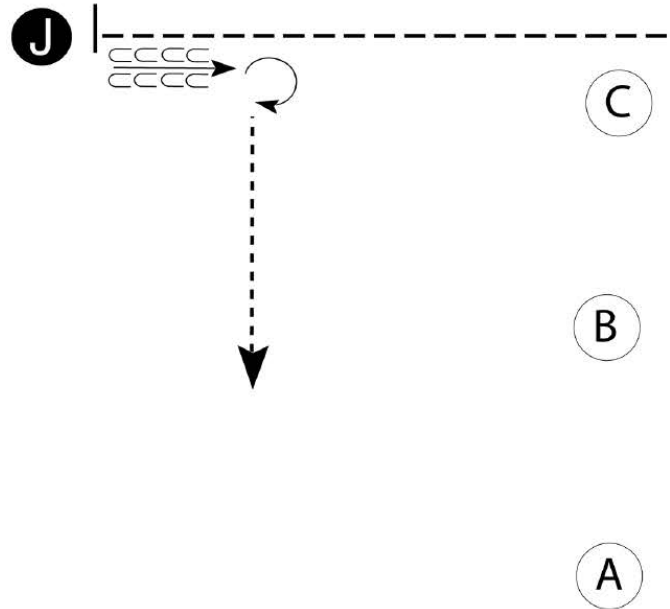

Be ready at A.

1. Walk to B.
2. Trot to C.
3. Trot a square corner around C.
4. Trot to the judge, stop and set up for inspection.
5. When dismissed back approximately one horse length.
6. Perform a 270 degree turn and walk straight away.

Follow the instructions of your ring steward.

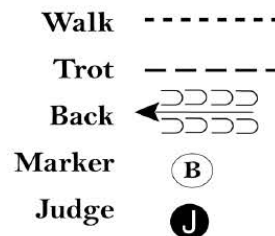

[S/2-39]

Pattern Provided by:

Carolyn Rice

Glacier Classic July 16

Showmanship Level One (all ages)

Show Date: 07-16-2022

W W W . H O R S E S H O W P A T T E R N S . C O M

W W W . H O R S E S H O W P A T T E R N S . C O M

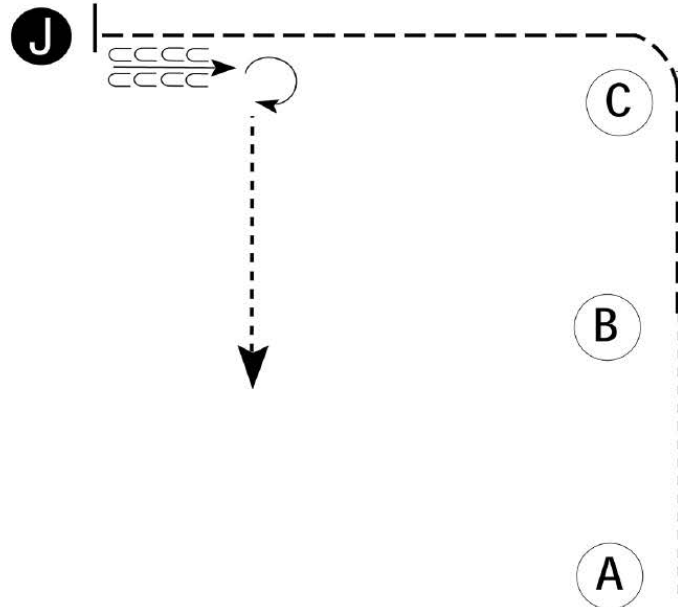

Be ready at A.

1. Walk to B.
2. Trot to and around C to judge.
3. Stop and set up for inspection.
4. When dismissed back approximately one horse length.
5. Perform a 270 degree turn and walk straight away.

Follow the instructions of your ring steward.

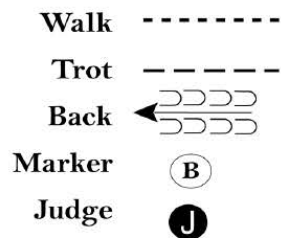

[S/1-39]

Pattern Provided by:
Carolyn Rice

Glacier Classic July 16

Level One Hunt Seat Equitation all ages (all ages)

Show Date: 07-16-2022

www.HorseShowPatterns.com

www.HorseShowPatterns.com

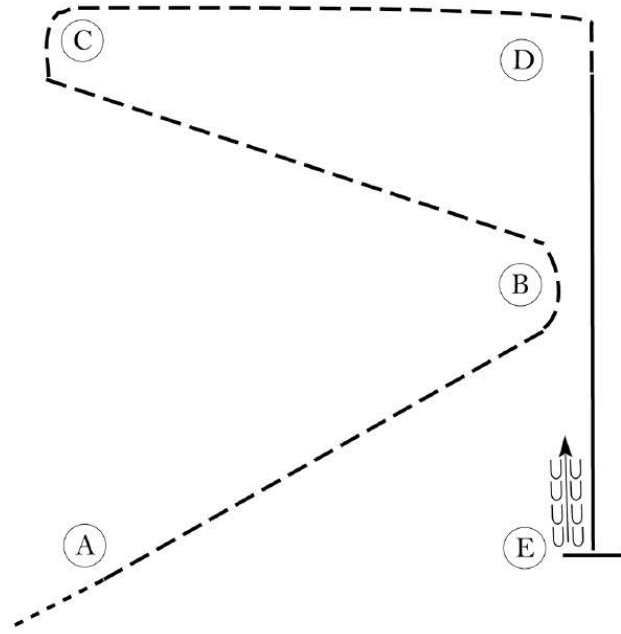

Be ready before A.

1. Walk to A.
2. Trot on the left diagonal from A to B, then change diagonals.
3. Trot on the right diagonal from B to C.
4. Sitting trot from C to D.
5. Canter on the right lead from D to E.
6. Stop at E and back approximately one horse length.

Walk to exit or follow instructions of your ring steward.

Walk	-----
Trot	- - - - -
Extended Trot	—————
Canter	—————
Leg Yield	
Lead Change	↘ ↙
Back	←←←←←
Marker	⊙ B
Sidepass	←←←←←
Hand Gallop	—————

[HSE/1-33]

Pattern Provided by:
Carolyn Rice

Glacier Classic July 16

Hunt Seat Equitation Walk Trot (all ages)

Show Date: 07-16-2022

www.HorseShowPatterns.com

www.HorseShowPatterns.com

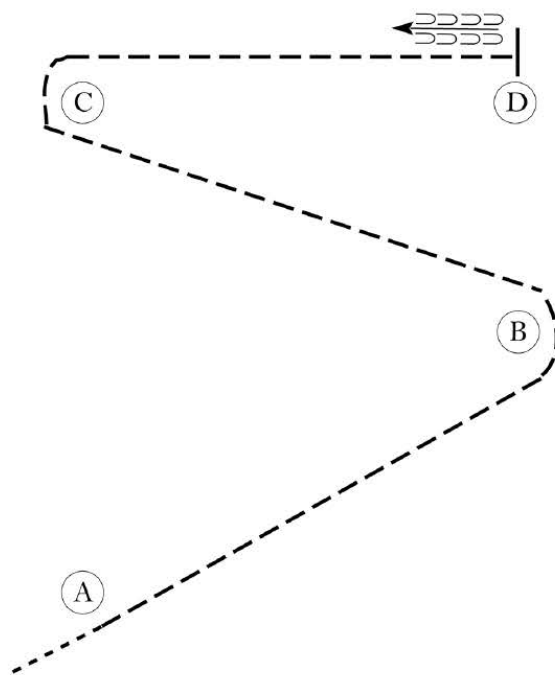

Be ready before A.

1. Walk to A.
2. Trot on the left diagonal from A to B, then change diagonals.
3. Trot on the right diagonal from B to C.
4. Sitting trot from C to D.
5. Stop at D and back approximately one horse length.

Walk to exit or follow instructions of your ring steward.

Walk	-----
Trot	- - - - -
Extended Trot	=====
Canter	—————
Leg Yield	
Lead Change	↘ ↙
Back	←←←
Marker	Ⓚ
Sidepass	← →
Hand Gallop	———

[HSE/WT-33]

Pattern Provided by:

Carolyn Rice

Glacier Classic July 16

Hunt Seat Equitation Youth, Amateur and Select (all ages)

Show Date: 07-16-2022

www.HorseShowPatterns.com

www.HorseShowPatterns.com

Be ready before A.

1. Walk to A.
 2. Trot on the left diagonal from A half way to B, then change diagonals.
 3. Trot on the right diagonal around B and half way to C, then change diagonals.
 4. Continue left diagonal to C.
 5. Sitting trot from C to D.
 6. Canter on the right lead from D to E.
 7. Stop at E. Turn 180 degrees to the right on the forehand.
 8. Back approximately one horse length.
- Walk to exit or follow instructions of your ring steward.

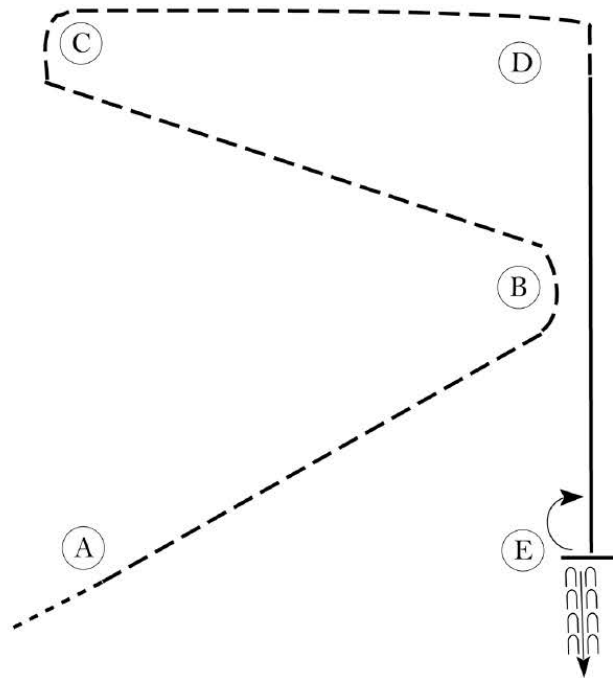

Walk	-----
Trot	- - - - -
Extended Trot	-----
Canter	-----
Leg Yield	
Lead Change	↘ ↙
Back	←←←←
Marker	⊙
Sidepass	←←←←
Hand Gallop	-----

[HSE/2-33]

Pattern Provided by:

Carolyn Rice

ALL WALK-JOG TRAIL CLASSES

Saturday Judge:
Carolyn Rice

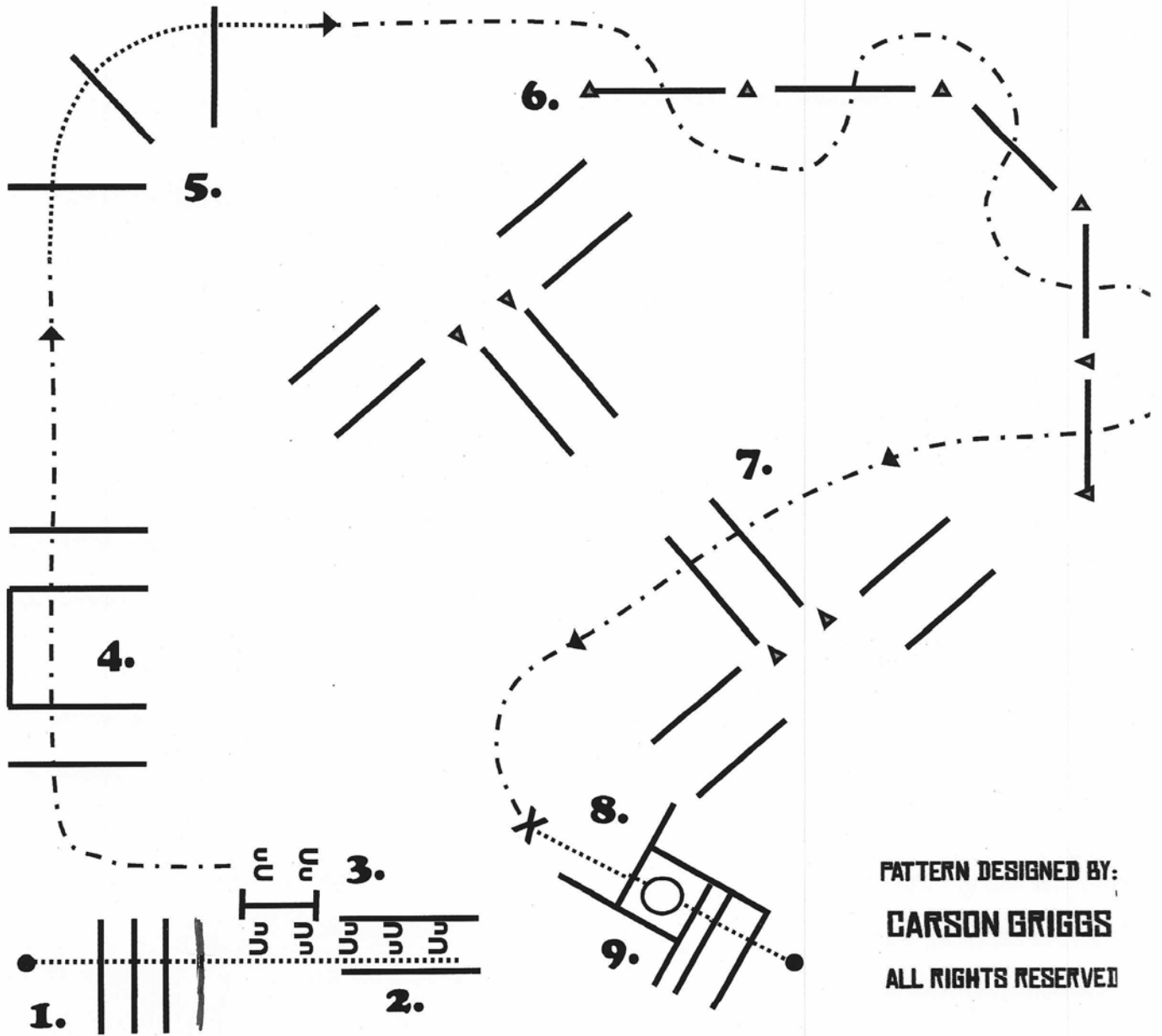

PATTERN DESIGNED BY:
CARSON GRIGGS
ALL RIGHTS RESERVED

- | | |
|--------------------------------------|--|
| 1. WALK OVER POLES INTO CHUTE | 6. JOG SERPENTINE |
| 2. BACK UP TO GATE | 7. CONTINUE JOG OVER 2 POLES |
| 3. OPEN GATE LEFT HAND | 8. STOP! WALK INTO BOX |
| 4. JOG OVER POLES | 9. 360 TURN EITHER WAY WALK OUT TO FINISH |
| 5. WALK BIG FAN | |

All Trail - except Walk/Jog

Saturday

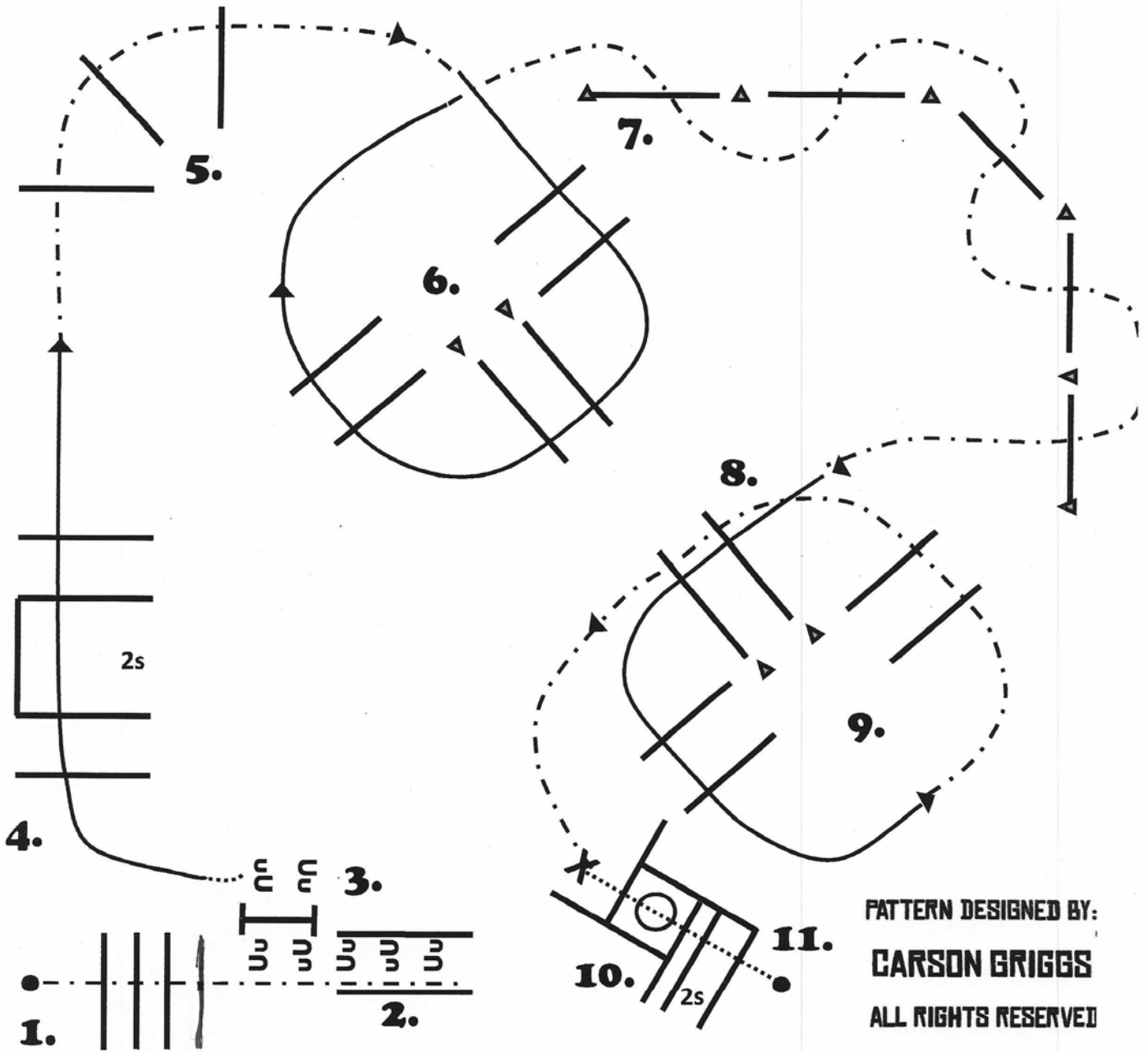

1. JOG OVER POLES INTO CHUTE
2. BACK UP TO GATE
3. OPEN GATE LEFT HAND
(YOU MAY WALK A FEW STEPS AWAY FROM GATE)
4. LOPE 4 POLES RIGHT LEAD
5. JOG BIG FAN
6. LOPE 3/4 WHEEL RIGHT LEAD

7. JOG SERPENTINE
8. LOPE LEFT LEAD FIRST 4 POLES
9. JOG NEXT 4 POLES
10. STOP OR BREAK TO WALK INTO BOX,
SPIN 360 DEGREES EITHER DIRECTION
11. WALK OUT OVER 3 POLES TO FINISH

PATTERN DESIGNED BY:
CARSON GRIGGS
ALL RIGHTS RESERVED

All Ranch Trail

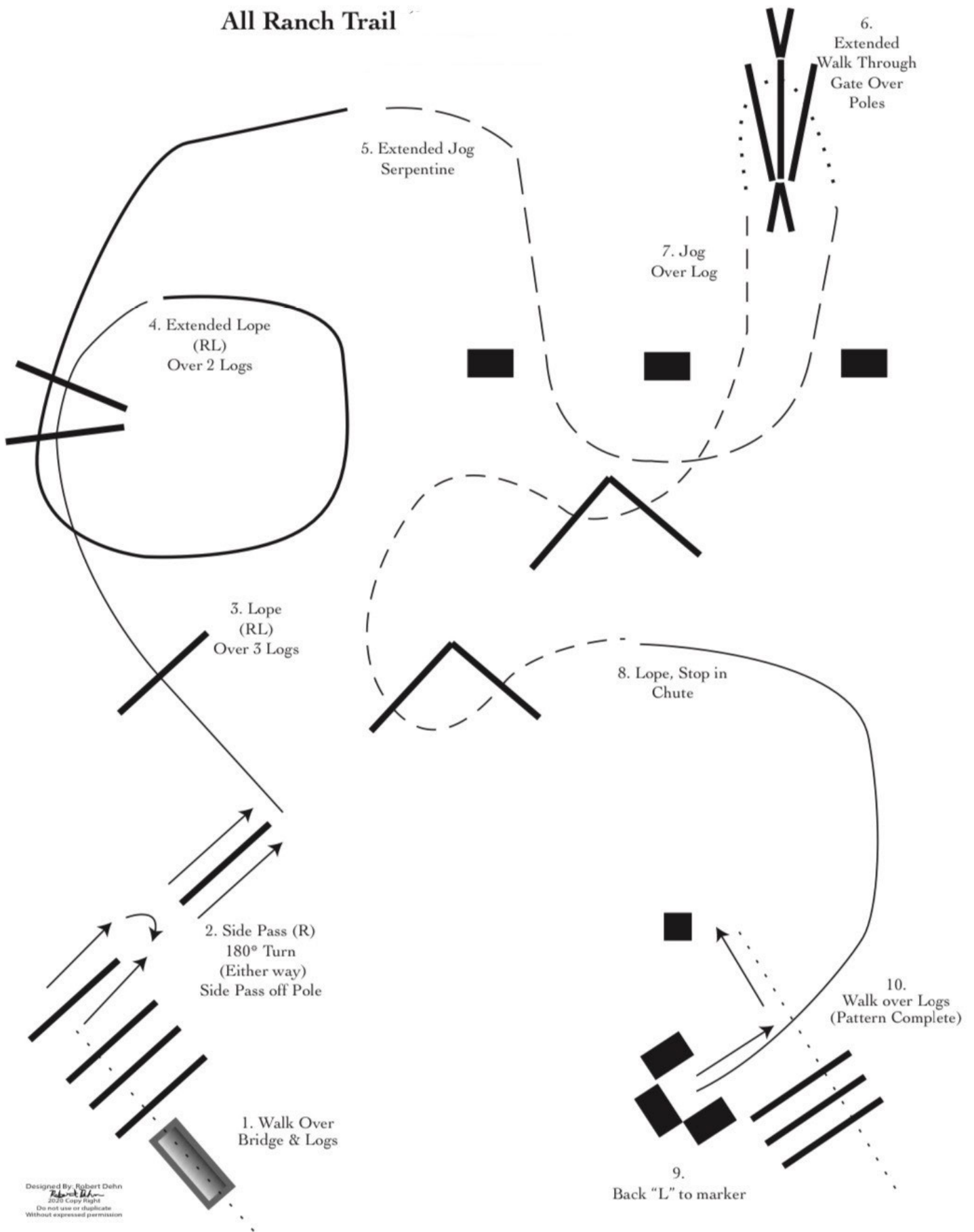

Glacier Classic July 16

Walk Trot Horsemanship (all ages)

Show Date: 07-16-2022

www.HorseShowPatterns.com

www.HorseShowPatterns.com



Be ready at A.

1. Jog from A past B.
2. Stop past B and perform a 270 degree turn to the left.
3. Extended jog to C.
4. Break to a walk and walk around C and halfway to D.
5. Stop and back approximately one horse length.

Follow the instructions of your ring steward.

Walk	-----
Jog	- - - - -
Extended Jog	— — — —
Lope	— — — —
Lead Change	— — — —
Back	← — — — —
Marker	(B)

[WH/WT-88]

Pattern Provided by:

Carolyn Rice

Glacier Classic July 16

Level One Horsemanship (all ages)

Show Date: 07-16-2022

www.HorseShowPatterns.com

www.HorseShowPatterns.com

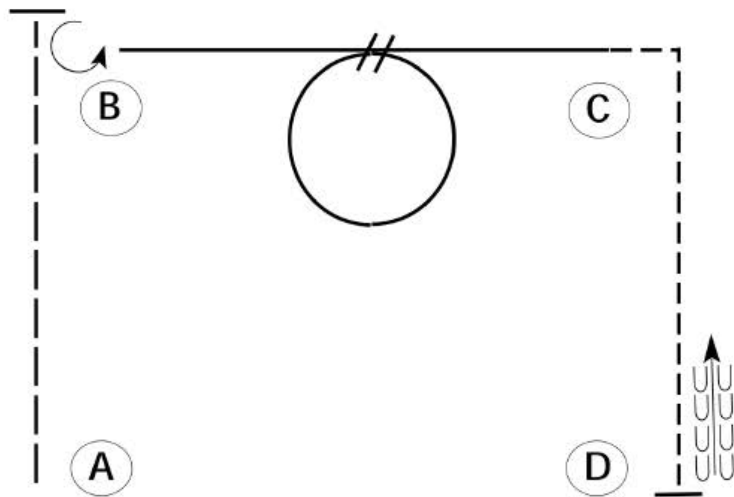

Be ready at A.

1. Extended trot from A past B.
2. Stop past B and perform a 270 degree turn to the left.
3. Lope on the left lead halfway to C.
4. Perform a simple lead change and lope a circle to the right.
5. Continue to lope to C.
6. At C, break to a jog and jog to D.
7. Stop and back approximately one horse length.

Follow the instructions of your ring steward.

Walk	-----
Jog	- - - - -
Extended Jog	— — — —
Lope	—————
Lead Change	⌘
Back	← — — — —
Marker	Ⓚ

[WH/1-88]

Pattern Provided by:
Carolyn Rice

Glacier Classic July 16

Horsemanship Youth ,Amateur and Select (all ages)

Show Date: 07-16-2022

www.HorseShowPatterns.com

www.HorseShowPatterns.com

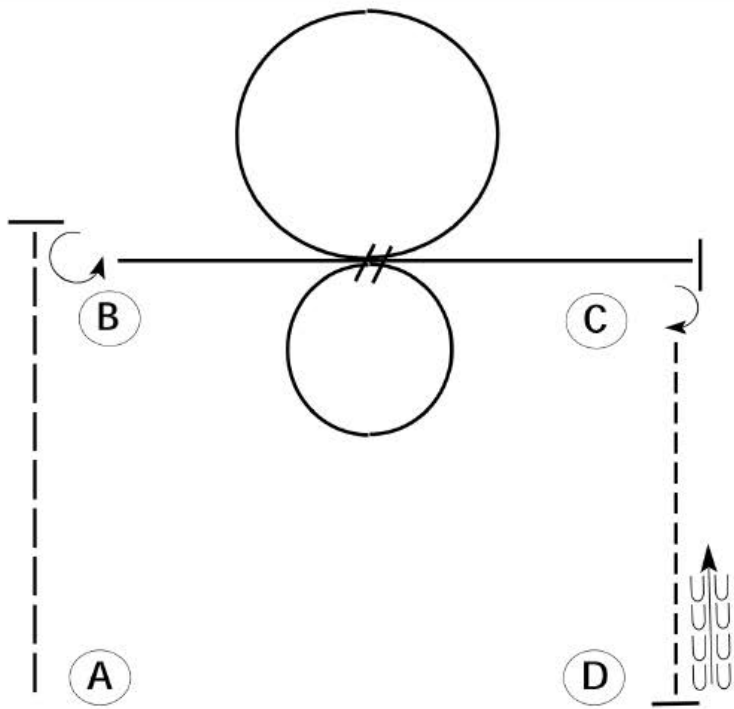

Be ready at A.

1. Extended trot from A past B.
2. Stop past B and perform a 270 degree turn to the left.
3. Lope on the right lead halfway to C.
4. Perform a small, slow circle to the right.
5. Change leads and perform a large, fast circle to the left.
6. Continue to lope past C and stop.
7. Perform a 1/4 turn to the right.
8. Jog to D.
9. Stop and back approximately one horse length.

Follow the instructions of your ring steward.

Walk	-----
Jog	- - - - -
Extended Jog	— — — —
Lope	—————
Lead Change	
Back	
Marker	(B)

[WH/2-88]

Pattern Provided by:

Carolyn Rice

Glacier Classic July 16

Western Riding Level One (all ages)

Show Date: 07-16-2022

www.HorseShowPatterns.com

www.HorseShowPatterns.com

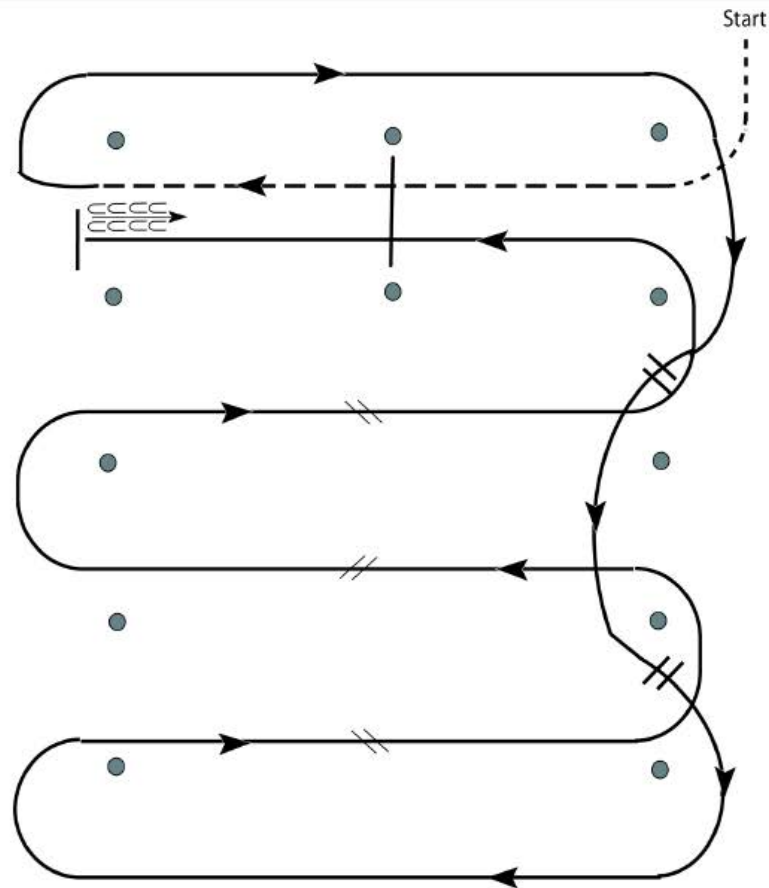

1. Walk, transition to jog, jog over log.
2. Transition to right lead and lope around end.
3. First line change.
4. Second line change. Lope around end of arena.
5. First crossing change.
6. Second crossing change.
7. Third crossing change.
8. Lope over log.
9. Lope, stop and back.

[WR/GP-4]

Pattern Provided by:

Carolyn Rice

Glacier Classic July 16

Western Riding all classes (all ages)

Show Date: 07-16-2022

www.HorseShowPatterns.com

www.HorseShowPatterns.com

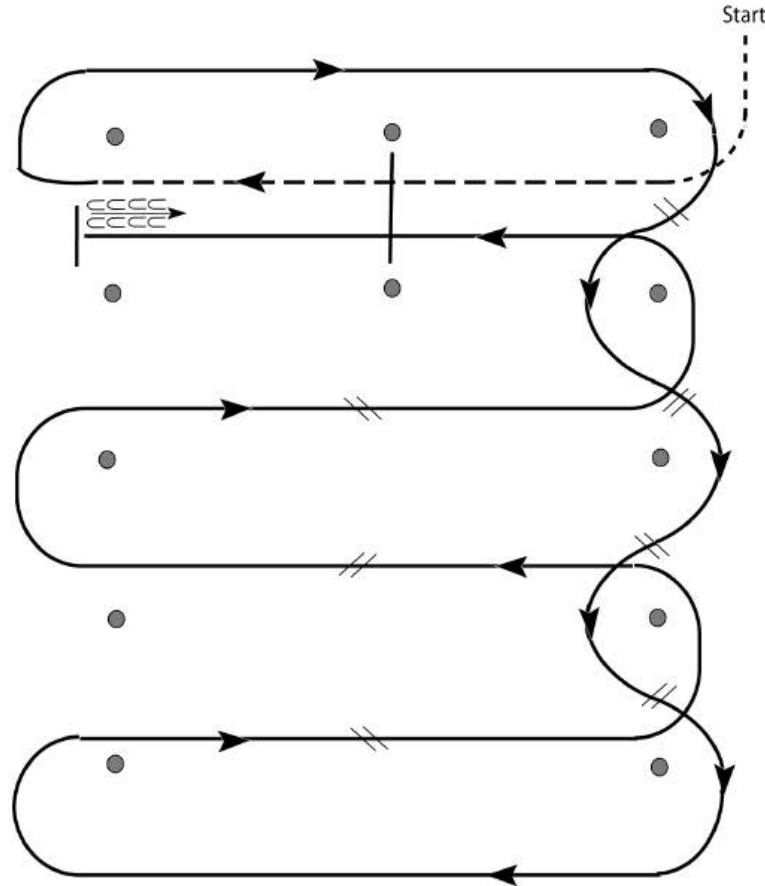

1. Walk, transition to jog, jog over log.
2. Transition to right.
3. First line change.
4. Second line change.
5. Third line change.
6. Fourth line change.
7. First crossing change.
8. Second crossing change.
9. Third crossing change.
10. Lope over log.
11. Lope, stop and back.

[WR/OP-4]

Pattern Provided by:

Carolyn Rice

Ranch Riding

Ranch Riding Stakes - Saturday

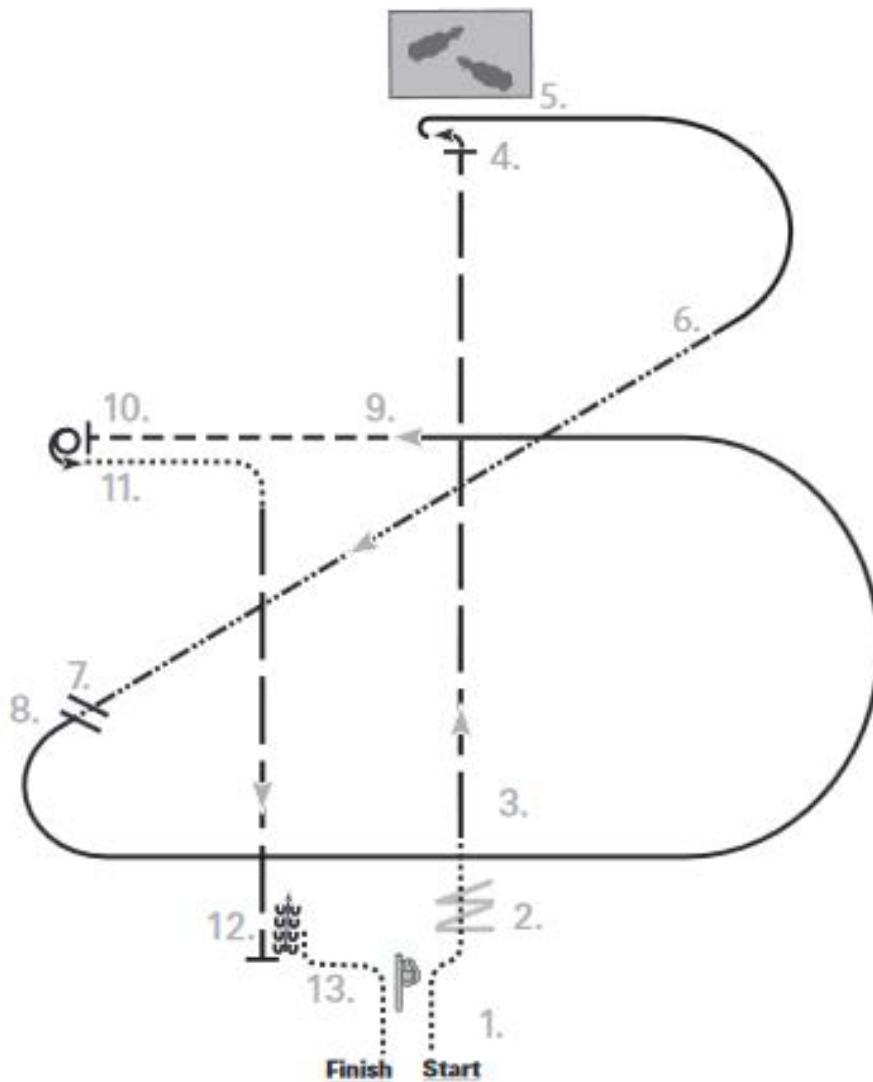

1. Enter at a walk, pick up saddle bags.
2. Walk over logs.
3. Extend trot to cattle pen.
4. Stop, pivot ¼ turn left, then rollback right.
5. Lope right lead.
6. Extended lope right lead across the diagonal.
7. Change leads (simple or flying).
8. Lope left lead.
9. Cross center and break to a trot.
10. Stop and execute 1½ spins to the left.
11. Walk, turn right, then extended trot.
12. Stop and back.
13. Walk over and replace saddle bags, then exit.

Pattern Legend

Walk
Jog/Trot	----
Lope/Canter	————
Extended Trot/Jog	— — — —
Log Yield	
Extended Lope	-----
Change Lead/Diagonal	≠
Gate	< >
Back	← ← ← → → →
Judge	Ⓜ
Cone	●
Sidepass	← ← ←

Glacier Classic July 16

Ranch Riding all classes (all ages)

Show Date: 07-16-2022

www.HorseShowPatterns.com

www.HorseShowPatterns.com

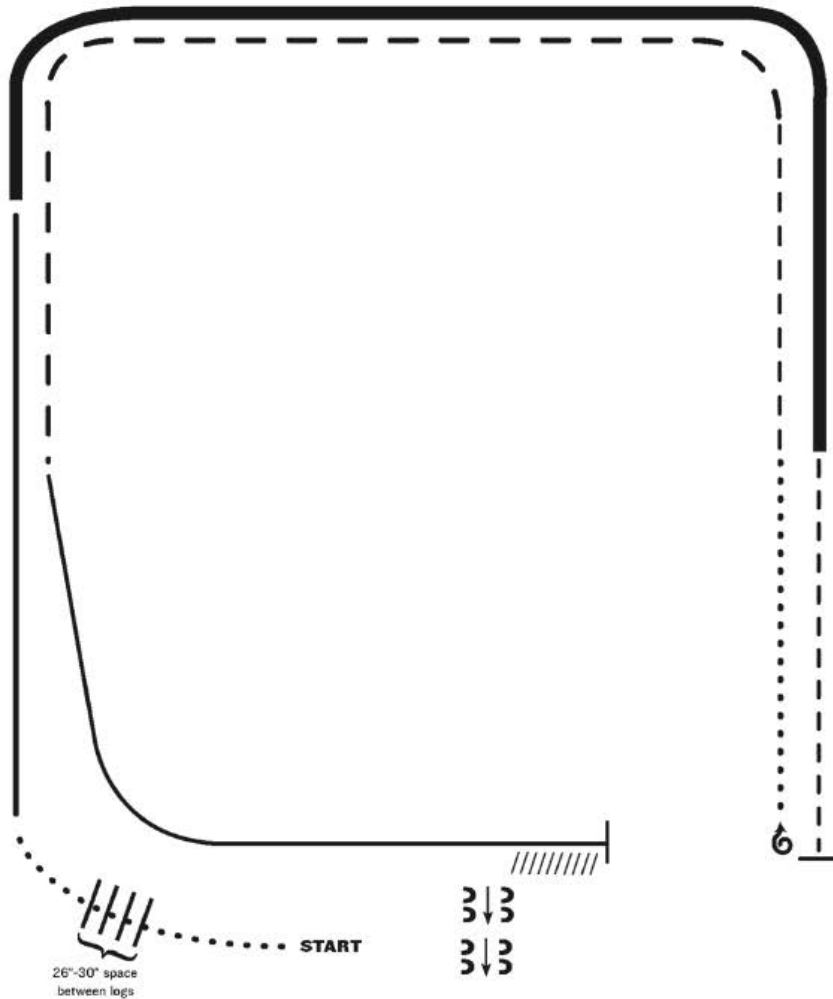

1. Walk
2. Walk over logs
3. Lope right lead
4. Extended lope (right lead)
5. Trot
6. Stop, 1 1/2 turns right
7. Walk
8. Trot
9. Extended trot
10. Lope left lead
11. Stop and Back
12. Side pass right

Note: The drawn description of this pattern is only intended for the general depiction of the pattern. Exhibitors should utilize the arena space to best exhibit their horses.

[RR/AQHA-6]

Pattern Provided by:

Carolyn Rice

Showmanship Stakes

July 17

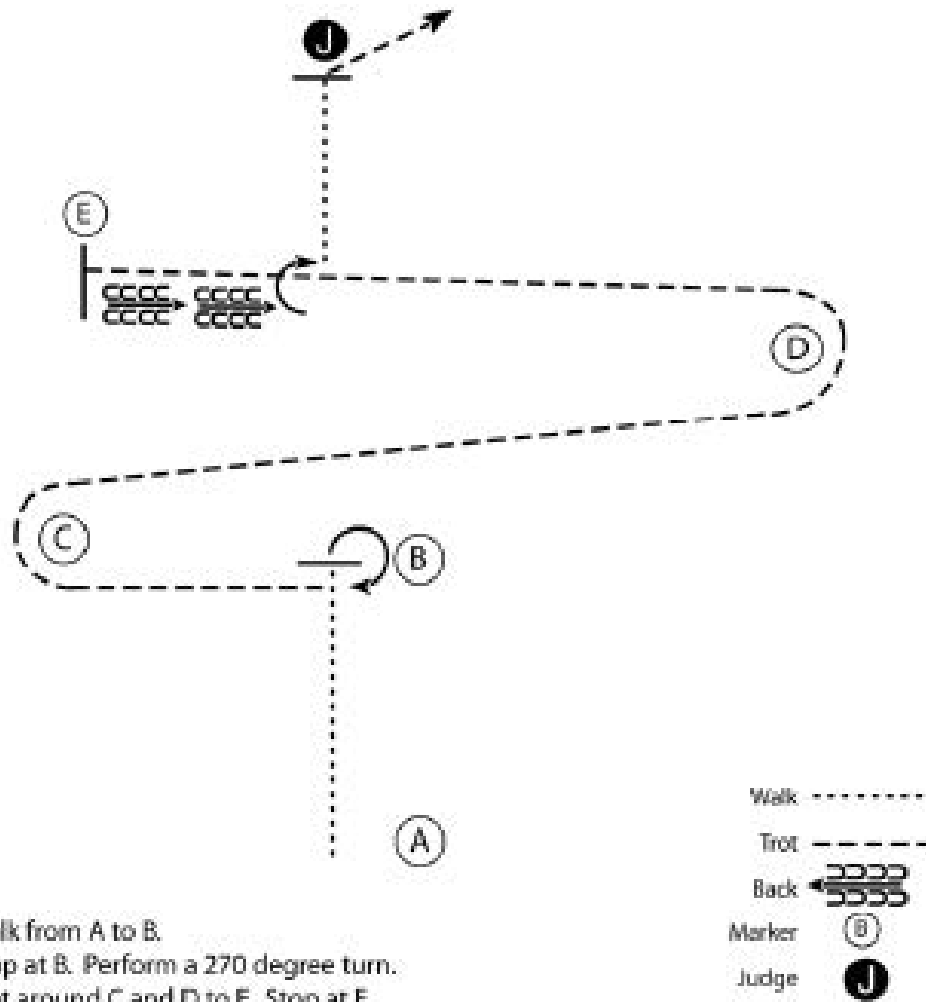

1. Walk from A to B.
2. Stop at B. Perform a 270 degree turn.
3. Trot around C and D to E. Stop at E.
4. Back 5 steps. Perform a 90 degree turn.
5. Walk to the Judge and set up for inspection.
6. When dismissed trot to the line-up.

Glacier Classic

Showmanship L1 Yth & AM

Show Date: 07-17-2022

w w w . H o r s e S h o w P a t t e r n s . c o m

w w w . H o r s e S h o w P a t t e r n s . c o m

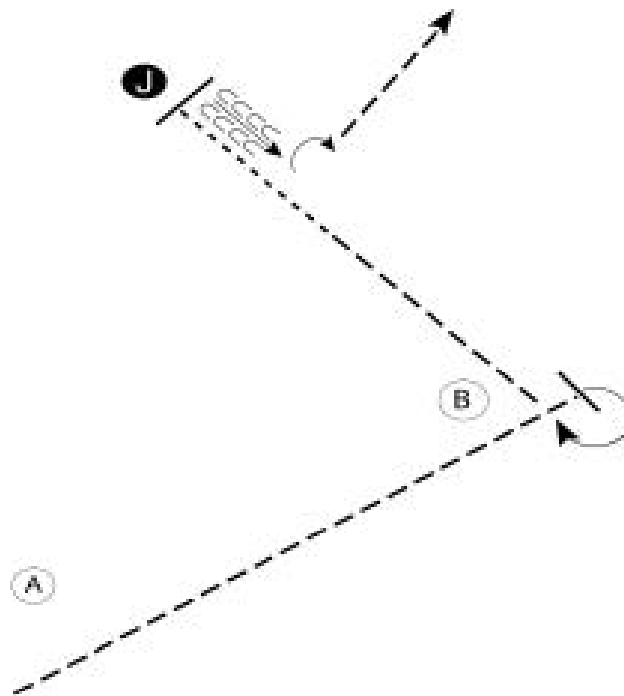

Be ready at A.

1. Trot past B and stop
 2. Perform a 270 degree turn
 3. Trot halfway to the Judge
 4. Break to the walk and walk to the Judge
 5. Stop and set up for inspection
 6. When dismissed back one horse length
 7. Perform a 90 degree turn and trot to the line-up
- Follow the instructions of your ring steward.

Walk
Trot	-----
Back	←○○○○
Marker	ⓑ
Judge	●

[S/1-27]

Pattern Provided by:

Chris Brown

Glacier Classic

Showmanship Yth. AM & Select

Show Date: 07-17-2022

www.HorseShowPatterns.com

www.HorseShowPatterns.com

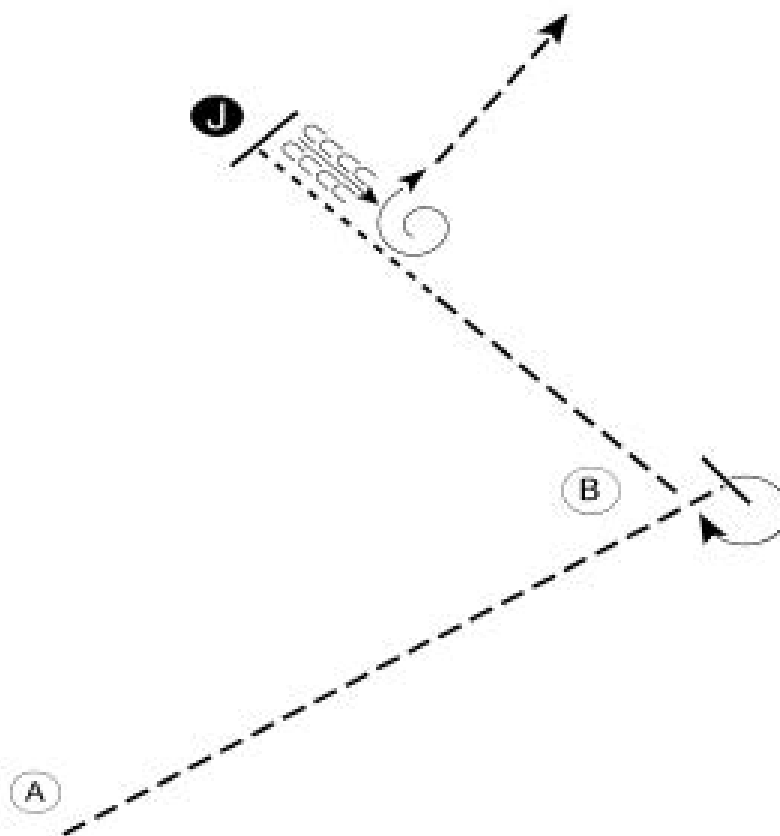

1. Begin at A. Trot past B and stop
2. Perform a 270 degree turn
3. Trot halfway to the Judge
4. Break to the walk and walk to the Judge
5. Stop and set up for inspection
6. When dismissed back one horse length
7. Perform a 450 degree turn and trot to the line-up

Walk
Trot	-----
Back	←←←←←
Marker	Ⓟ
Judge	Ⓝ

[S/2-27]

Pattern Provided by:

Chris Brown

Glacier Classic

Hunt Seat Equitation W/T

Show Date: 07-17-2022

w w w . H o r s e S h o w P a t t e r n s . c o m

w w w . H o r s e S h o w P a t t e r n s . c o m

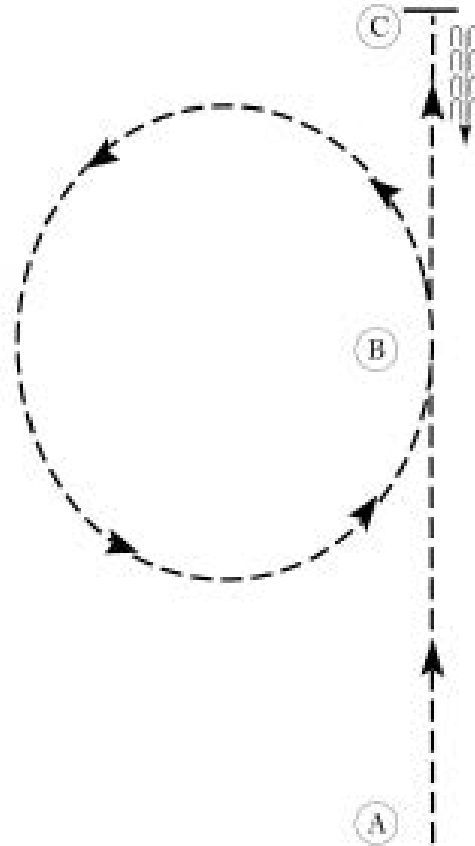

1. Posting trot on the left diagonal from A to B.
2. At B posting trot a circle to the left on the right diagonal.
3. Sitting trot to C.
4. Stop at C and back approximately one horse length.

Exit at a sitting trot.

Walk
Trot	-----
Extended Trot	-----
Canter	—————
Leg Yield	
Lead Change	↘
Back	←○○○○
Marker	ⓑ
Sidepass	←←
Hand Gallop	—————

[HSE/WT-21]

Pattern Provided by:

Chris Brown

Glacier Classic

Hunt Seat Equitation L1

Show Date: 07-17-2022

w w w . H o r s e S h o w P a t t e r n s . c o m

w w w . H o r s e S h o w P a t t e r n s . c o m

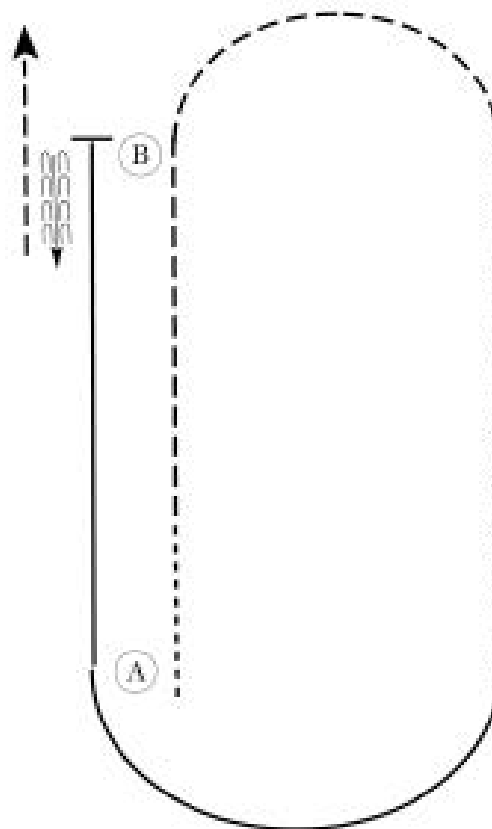

Be ready at A.

1. Walk approximately 2 horse lengths.
2. Posting trot on the left diagonal to B and in a half circle until even with B.
3. Change diagonals and trot until even with A.
4. Canter on the right lead in a half circle and until even with B.
5. Halt and back approximately one horse length.
6. Exit pattern at a sitting trot.

Follow the instructions of your ring steward.

Walk	-----
Trot	- - - - -
Extended Trot	— — — — —
Canter	— — — — —
Leg Yield	
Lead Change	— / —
Back	← ← ← ← ←
Marker	⊙
Sidepass	← ←
Hand Gallop	— — — — —

[HSE/1-56]

Pattern Provided by:

Chris Brown

Glacier Classic

Hunt Seat Equitation Yth, AM & Select

Show Date: 07-17-2022

www.HorseShowPatterns.com

www.HorseShowPatterns.com

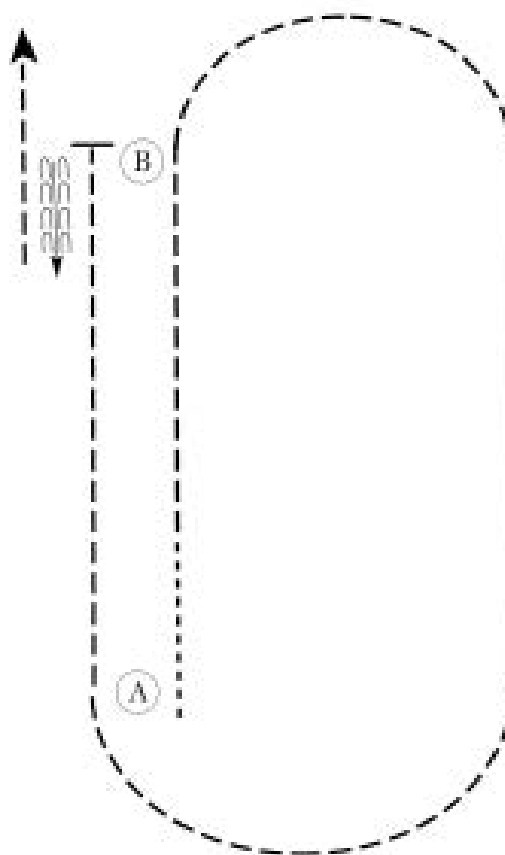

Be ready at A.

1. Walk approximately 2 horse lengths.
2. Posting trot on the left diagonal to B and in a half circle until even with B.
3. Canter on the right lead until even with A.
4. Sitting trot in a half circle to A.
5. Posting trot on the right diagonal to B.
6. Halt and back approximately one horse length.
7. Exit pattern at a sitting trot.

Follow the instructions of your ring steward.

Walk	-----
Trot	- - - - -
Extended Trot	-----
Canter	-----
Leg Yield	
Lead Change	///
Back	←←←←
Marker	(B)
Sidepass	←←
Hand Gallop	-----

[HSE/2-56]

Pattern Provided by:

Chris Brown

Sunday - walk/jog Trail

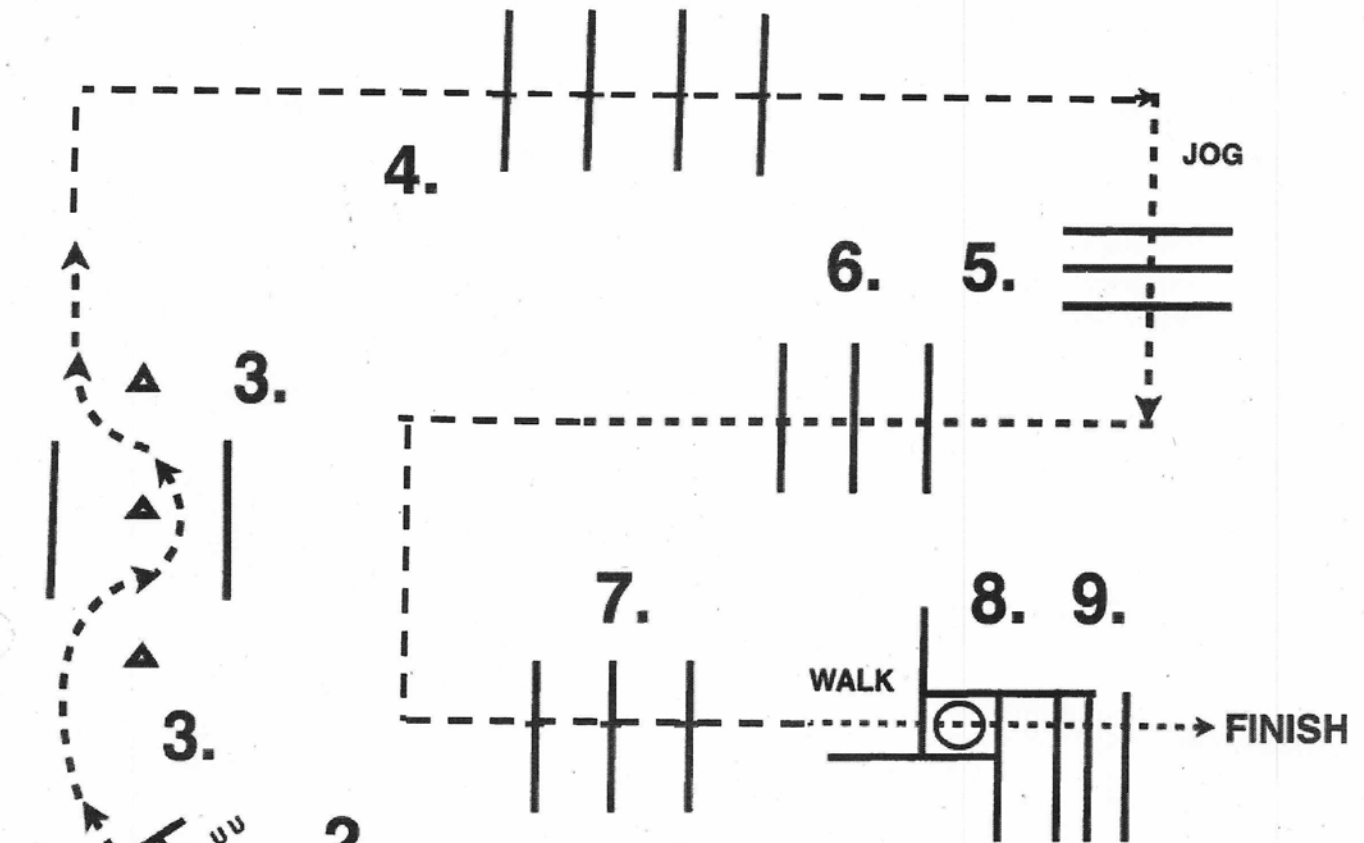

1. Walk between cones turn to the right back between cones to gate.
2. Walk through gate
3. Jog serpentine
4. Jog Poles
5. Jog Poles
6. Jog Poles
7. Jog Poles
8. Stop or break to the alk into box and 360 either way
9. Walk over poles to finish

Sunday

Judge: Christi Brown.

All Trail - - except WJ

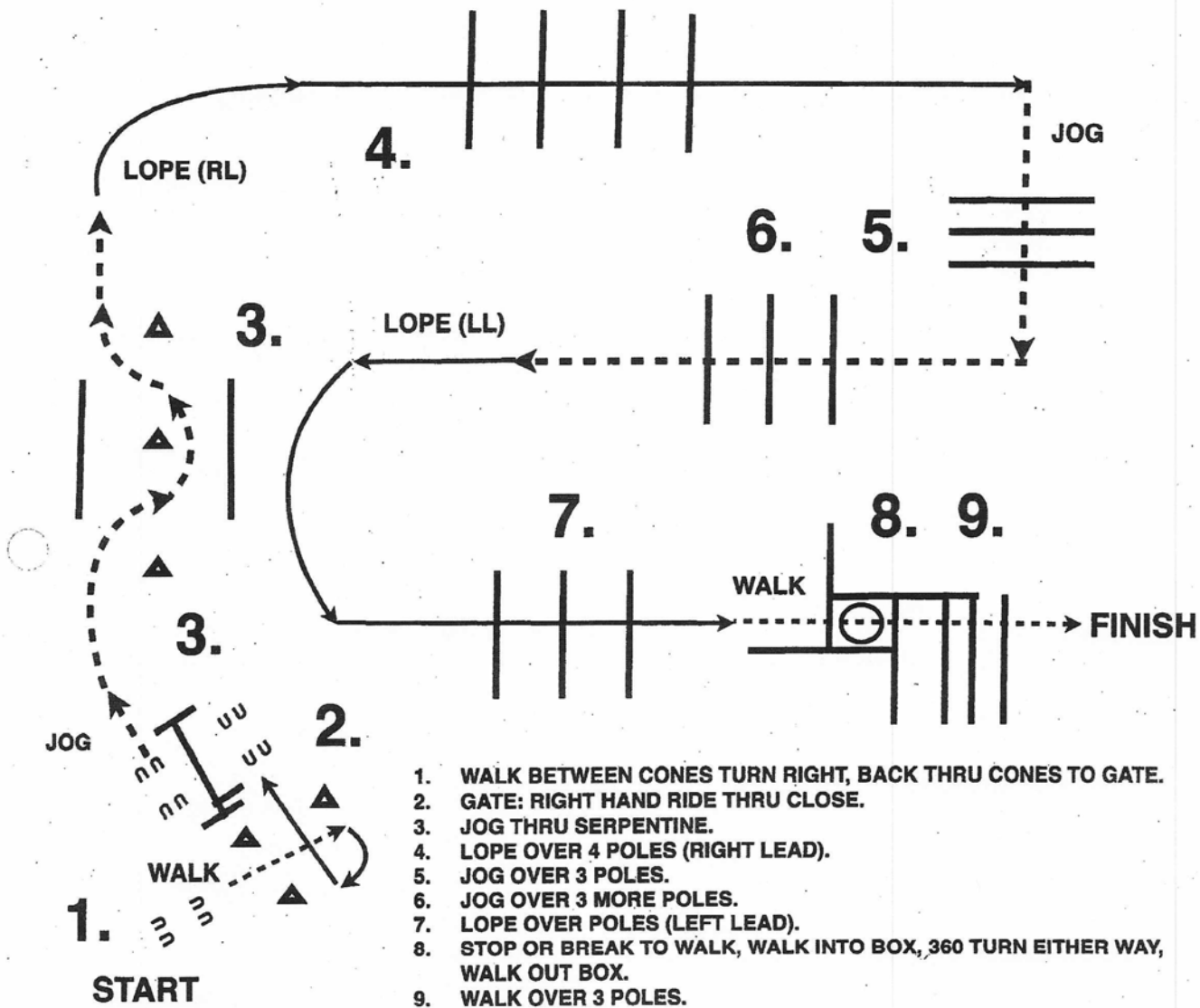

1. WALK BETWEEN CONES TURN RIGHT, BACK THRU CONES TO GATE.
2. GATE: RIGHT HAND RIDE THRU CLOSE.
3. JOG THRU SERPENTINE.
4. LOPE OVER 4 POLES (RIGHT LEAD).
5. JOG OVER 3 POLES.
6. JOG OVER 3 MORE POLES.
7. LOPE OVER POLES (LEFT LEAD).
8. STOP OR BREAK TO WALK, WALK INTO BOX, 360 TURN EITHER WAY, WALK OUT BOX.
9. WALK OVER 3 POLES.

Ranch Trail Pattern #1

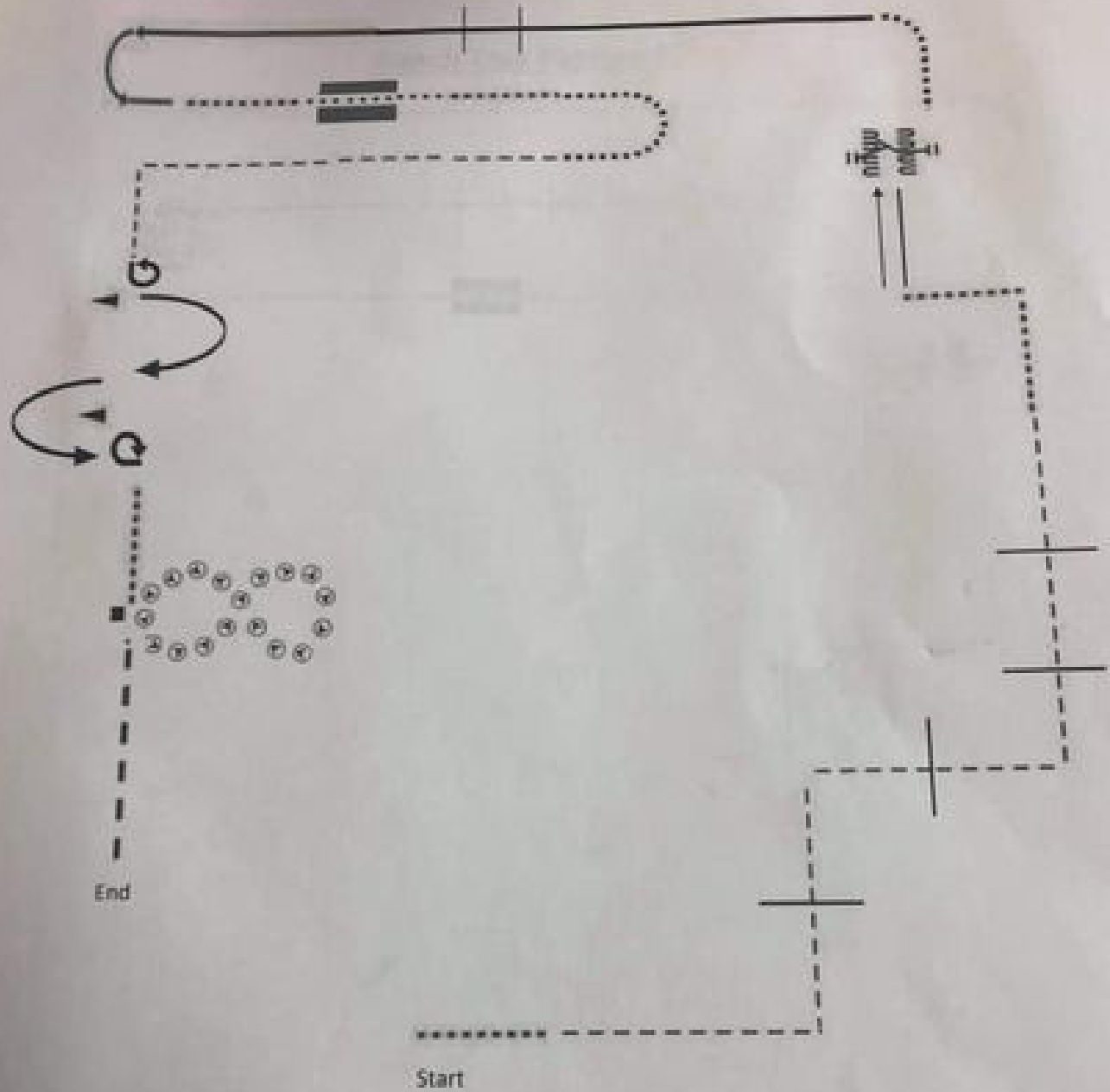

- | | |
|-----------------------------|-----------------------------------|
| 1. Walk In | 11. Walk over bridge |
| 2. Trot | 12. Trot |
| 3. Trot over logs | 13. Stop at cone |
| 4. Walk | 14. 270° turn left |
| 5. Side pass log right | 15. Back serpentine through cones |
| 6. Right hand push gate | 16. 270 ° turn right |
| 7. Walk | 17. Walk to drag log |
| 8. Lope left lead | 18. Drag log (figure 8) |
| 9. Lope left lead over logs | 19. Extended trot out |
| 10. Walk | |

Glacier Classic

Western Horsemanship W/T

Show Date: 07-17-2022

www.HorseShowPatterns.com

www.HorseShowPatterns.com

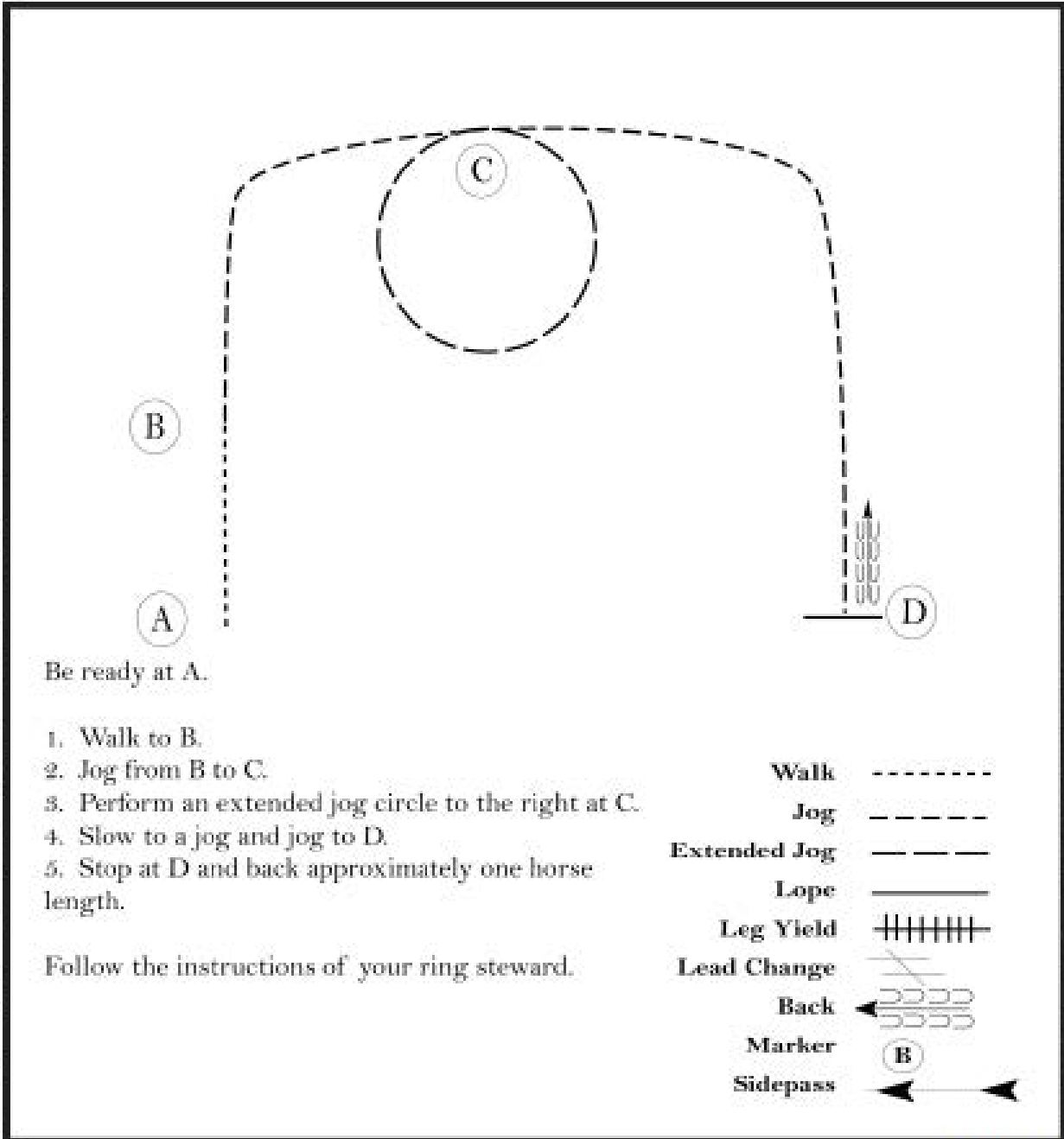

Pattern Provided by:

Chris Brown

[WH/WT-33]

Glacier Classic

Western Horsemanship L1

Show Date: 07-17-2022

www.HorseShowPatterns.com

www.HorseShowPatterns.com

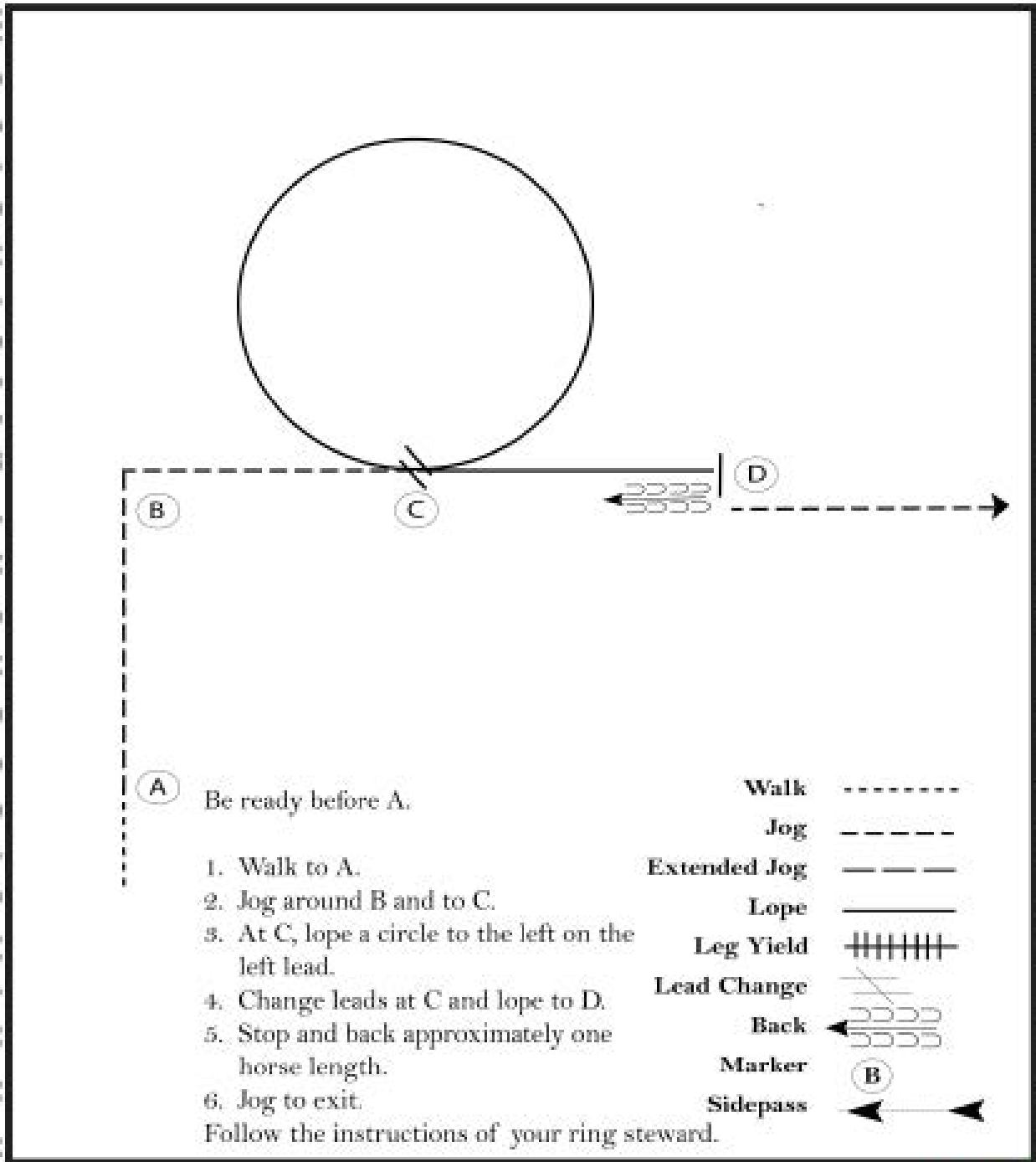

(A) Be ready before A.

1. Walk to A.
 2. Jog around B and to C.
 3. At C, lope a circle to the left on the left lead.
 4. Change leads at C and lope to D.
 5. Stop and back approximately one horse length.
 6. Jog to exit.
- Follow the instructions of your ring steward.

Walk	-----
Jog	- - - - -
Extended Jog	— — — —
Lope	—————
Leg Yield	
Lead Change	↖ ↗
Back	← ← ← ← ←
Marker	(B)
Sidepass	← →

[WH/1-65]

Pattern Provided by:
Chris Brown

Glacier Classic

Western Horsemanship Yth, AM & Select

Show Date: 07-17-2022

www.HorseShowPatterns.com

www.HorseShowPatterns.com

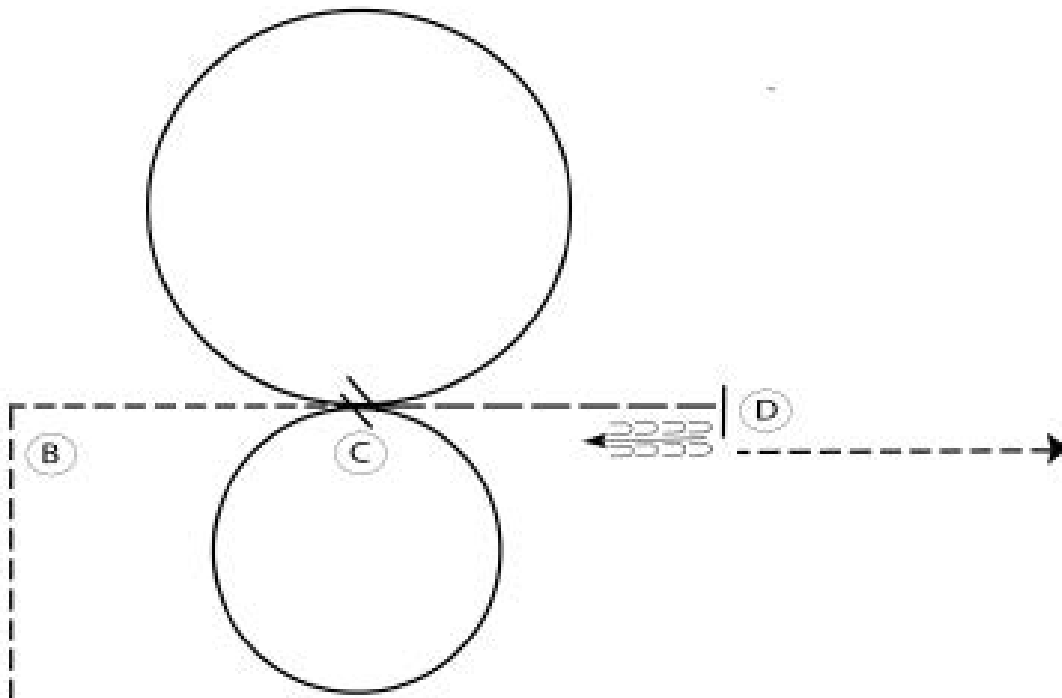

(A)

Be ready before A.

1. Walk to A.
 2. Jog around B and to C.
 3. Lope a small circle to the right.
 4. Change leads at C and lope a larger circle to the left.
 5. Extend the jog at C and to D.
 6. Stop and back approximately one horse length.
 7. Jog to exit.
- Follow the instructions of your ring steward.

Walk	-----
Jog	- - - - -
Extended Jog	— — — —
Lope	—————
Leg Yield	
Lead Change	↗ ↘
Back	← ← ← ← ←
Marker	(B)
Sidepass	↔ ↔

[WH/2-65]

Pattern Provided by:

Chris Brown

Glacier Classic

All Western Riding

Show Date: 07-17-2022

www.HorseShowPatterns.com

www.HorseShowPatterns.com

WESTERN RIDING - PATTERN 6

LEGEND

.....	Walk
---	Jog
-----	Lope
	Back
	Lead Changing Line

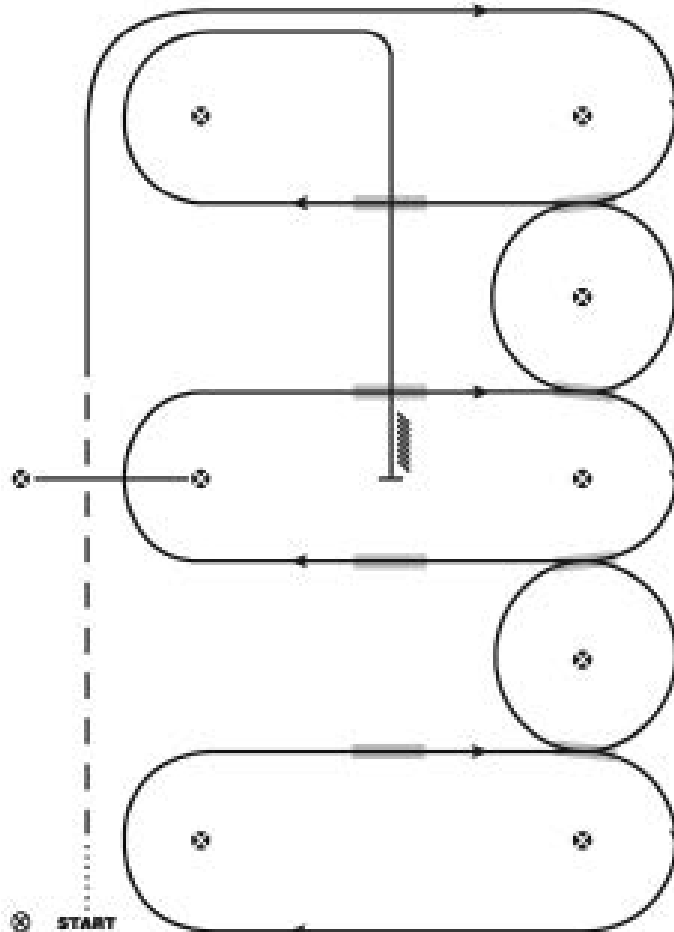

1. Walk at least 10 feet from start cone to the first marker, transition to jog, jog over jog
2. Transition to the lope right lead & lope around end
3. First line change
4. Second line change
5. Third line change
6. Fourth line change lope around the end of arena
7. First crossing change
8. Second crossing change
9. Lope over jog
10. Third crossing change
11. Fourth crossing change
12. Lope up the center, stop & back

Revised 04-07-2021

[WR/OP-6]

Pattern Provided by:

Chris Brown

Glacier Classic

All Ranch Riding

Show Date: 07-17-2022

w w w . H o r s e S h o w P a t t e r n s . c o m

w w w . H o r s e S h o w P a t t e r n s . c o m

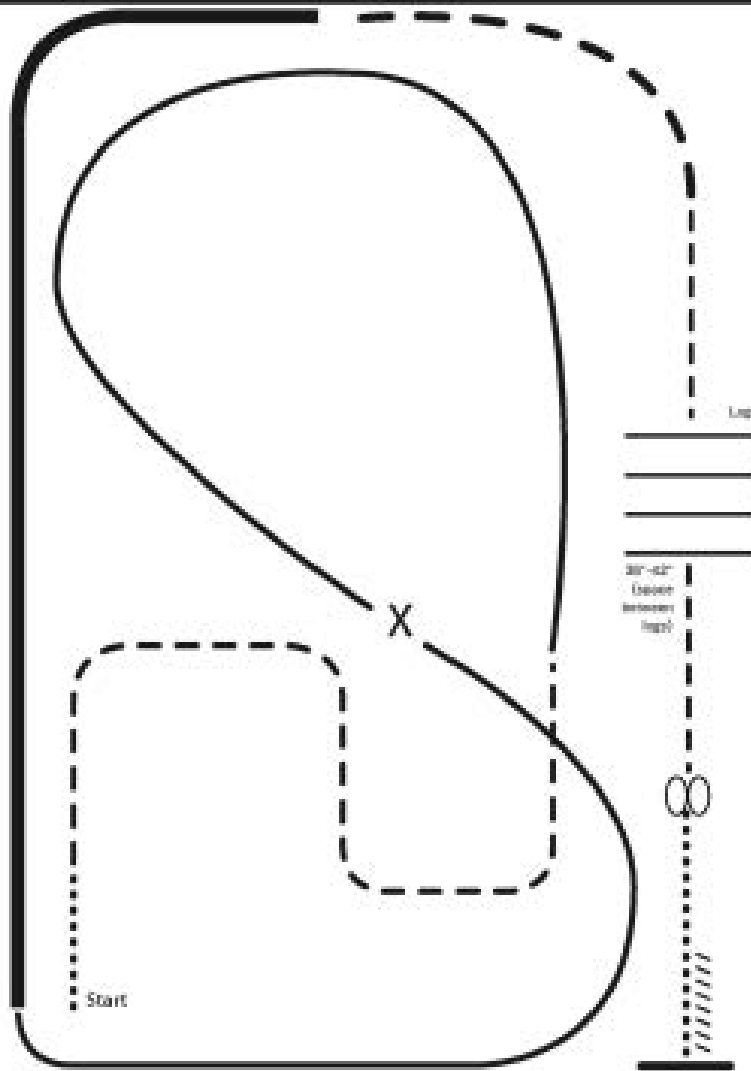

- X — Lead Change
- Walk
- Trot
- Fast Trot
- Lope
- Fast Lope
- ~~~~~ Back

1. Walk
2. Trot serpentine
3. Lope left lead around the end of the arena and then diagonally across the arena
4. Change leads (simple or flying) and
5. Lope on the right lead around end of the arena
6. Extend lope on the straight away and around corner to the center of the arena
7. Extend trot around corner of the arena
8. Collect to a trot
9. Trot over logs
10. Stop, do 360 degree turn each direction (either direction is) (L-R or R-L)
11. Walk, stop and back

[RR/AQHA-3]

Pattern Provided by:
Chris Brown

Glacier Classic

Reining L1 AM

Show Date: 07-17-2022

REINING PATTERN B

Approved only for Level I Youth & Amateur, Youth 13 & Under

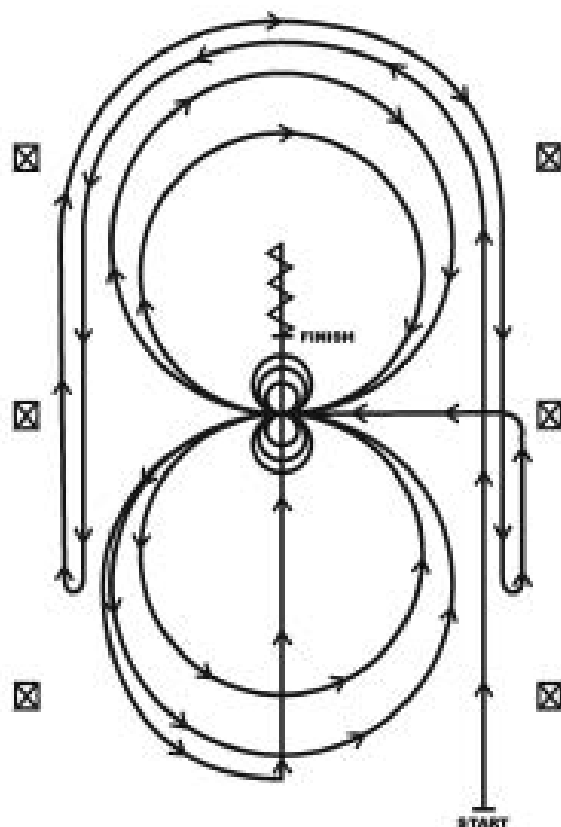

1. Beginning, lope straight up the right side of the arena, circle the top of the arena, run straight down the opposite or left side of the arena past the center mark, and do a right rollback—no hesitation.
2. Continue straight up the left side of the arena, circle back around the top of the arena, run straight down the right side of the arena past the center marker and do a left rollback—no hesitation.
3. Continue up the right side of the arena to the center marker, at the center marker the horse should be on the left lead and complete two circles to the left, one large fast and one small slow. Stop at center.
4. Complete three spins to the left. Hesitate.
5. Complete two circles to the right, one large fast and one small slow. Stop at center.
6. Complete three spins to the right. Hesitate.
7. Begin a large circle to the left, do not close the circle. Continue up the center of the arena past the center marker and do a sliding stop. 8. Back up at least ten feet. Hesitate to demonstrate completion of the pattern. See the Judges' Guide for a summary of other allowances made in the Handbook.

Pattern Provided by:

Chris Brown

©2022 HorseShowPatterns.com. All Rights Reserved.

[R/AQHAP-B]

Glacier Classic

Reining

Show Date: 07-17-2022

REINING PATTERN 9

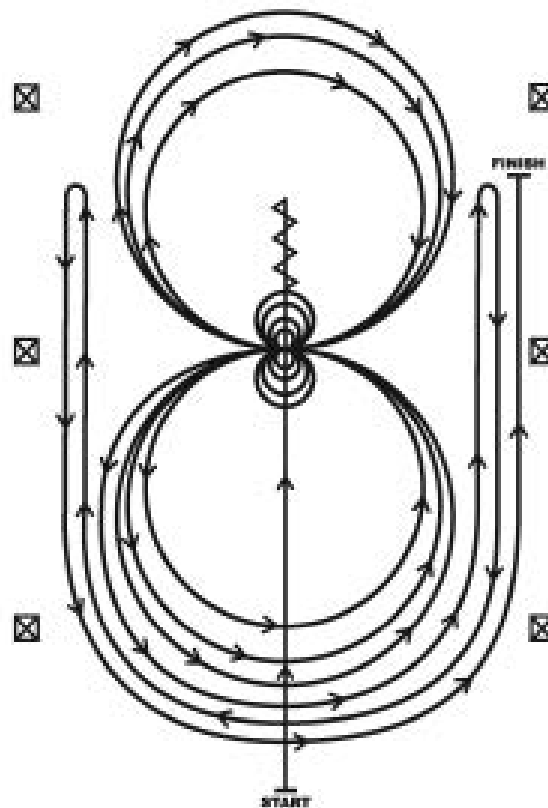

1. Run past the center marker and do a sliding stop. Back up to the center of the arena or at least ten feet (three meters). Hesitate.
2. Complete four spins to the right. Hesitate.
3. Complete four and one-quarter spins to the left so that horse is facing the left wall or fence. Hesitate.
4. Beginning on the left lead, complete three circles to the left: the first circle small and slow; the next two circles large and fast. Change leads at the center of the arena.
5. Complete three circles to the right: the first circle small and slow; the next two circles large and fast. Change leads at the center of the arena.
6. Begin a large circle to the left but do not close this circle. Run up the right side of the arena past the center marker and do a right rollback at least twenty feet (six meters) from the wall or fence—no hesitation.
7. Continue back around the previous circle but do not close this circle. Run up the left side of the arena past the center marker and do a left rollback at least twenty feet (six meters) from the wall or fence—no hesitation.
8. Continue back around previous circle but do not close this circle. Run up right side of the arena past the center marker and do a sliding stop at least twenty feet (six meters) from the wall or fence. Hesitate to demonstrate completion of the pattern.

[R/AQHAP-9]

Pattern Provided by:

Chris Brown